



# Pearl Mantels®

Makers of fine furniture for your hearth and home



[www.pearlmantels.com](http://www.pearlmantels.com)



# The Shenandoah: Two Hanging Options!

Mantels are hand painted and hand distressed. Actual finish colors, textures and distressing may vary from photos.

**Hang with or without Corbels:**  
Use as Floating Shelves without corbels  
Or Install with corbels (included) to add a Unique Look!

Shelf Only



412 shown in #50 Medium Rustic Distressed Finish 60" length shown without corbels.

Shelf with Corbels

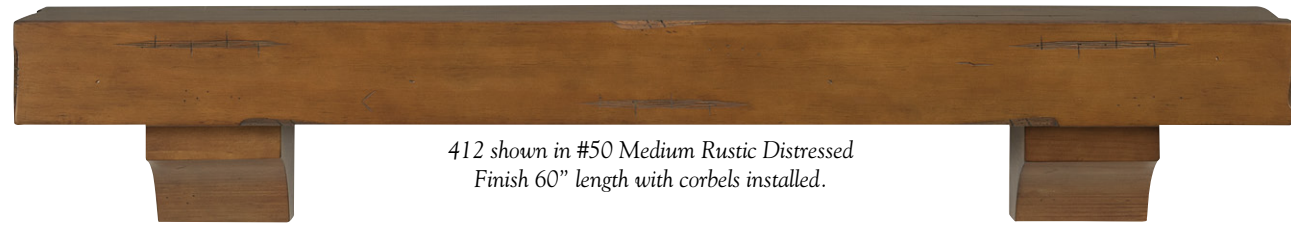

412 shown in #50 Medium Rustic Distressed Finish 60" length with corbels installed.

## Shenandoah No. 412

Install with or without corbels

Available in Pine Wood 48", 60", and 72" lengths in the following finishes:

Unfinished Distressed paint and stain grade, #10 Dune Distressed, #20 Espresso Distressed, #50 Medium Rustic Distressed in 60" and 70" lengths, #70 Cherry Rustic Distressed in 60" and 70" lengths, and #09 Farmhouse Distressed in 48" length only (see back cover photo).

Featured by *Good Housekeeping* in their article "25 Stylish Fall Mantel Decor Ideas to Cozy Up Your Space."

	412-48	412-60	412-72
Top Shelf length:	48"	60"	72"
Top Shelf Depth:	9"	9"	9"
Bottom Base length:	48"	60"	72"
Bottom Base Depth:	9"	9"	9"
Distance b/t Corbels:	25"	35"	42"
Width of each Corbel:	6.5"	6.5"	6.5"
Height of each Corbel:	5.5"	5.5"	5.5"
Overall Height w/o Corbel:	5"	5"	5"
Overall Height w/Corbel:	10.5"	10.5"	10.5"

### LOOK FOR THE PEARL!

Each of our pieces is lovingly branded with a Pearl inlay—Our Certificate of Authenticity



No. 412 shown in #50 Medium Rustic Distressed Finish.

The pearl is neatly masked on our Unfinished pieces making it easy to paint or stain.

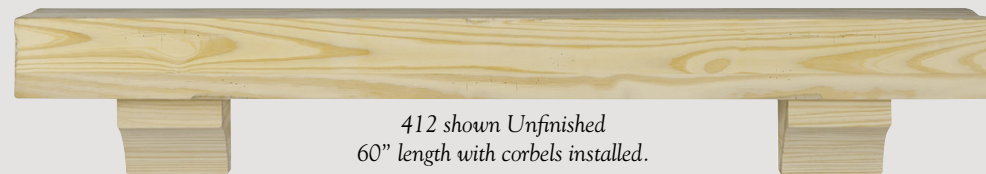

412 shown Unfinished 60" length with corbels installed.

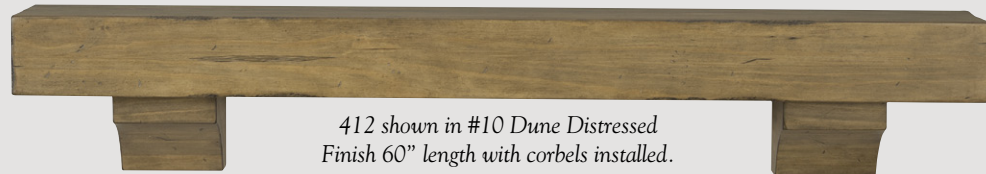

412 shown in #10 Dune Distressed Finish 60" length with corbels installed.

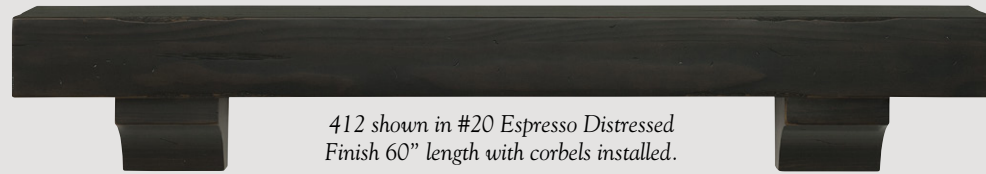

412 shown in #20 Espresso Distressed Finish 60" length with corbels installed.



412 shown in #50 Medium Rustic Distressed Finish 60" length with corbels installed.

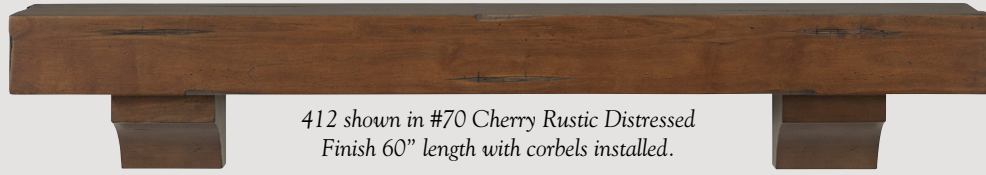

412 shown in #70 Cherry Rustic Distressed Finish 60" length with corbels installed.

#### WARNING! HEAT CLEARANCES MUST BE ADHERED TO

FOR INSTALLATION OF THIS PRODUCT; ADHERE TO YOUR LOCAL BUILDING HEAT CLEARANCE CODES AND HEAT CLEARANCES AS STATED BY THE MANUFACTURER OF YOUR SPECIFIC FIREBOX OR STOVE MODEL. FAILURE TO DO SO WILL VOID THE PRODUCT WARRANTY. ALWAYS CONSULT A PROFESSIONAL.

Product lifestyle photos and drawings are for illustration only. For all surrounds and shelves: hardware is not included to attach the hanger board to the mounting surface.

\*All Pearl Mantels are manufactured individually. Measurements listed are standard, but tolerances may vary. We encourage you to measure your mantel prior to installation and for all custom-fit applications.

Visit our website for more photos and information on our products and fine furniture quality finishes—[www.pearlmantels.com](http://www.pearlmantels.com)

Actual finish colors and distressing may vary from photos. © 1995-2023 Pearl Mantels Corporation®

# Your Mantel Headquarters!

Mantels are hand painted and hand distressed. Actual finish colors, textures and distressing may vary from photos.

## Bedford No. 365

Available only in No. 63 Gristmill Finish.

48", 60", and 72" lengths.

Bedford 365	365-48-63	365-60-63	365-72-63
Top Shelf length:	48"	60"	72"
Top Shelf Depth:	9"	9"	9"
Bottom Base length:	48"	60"	72"
Bottom Base Depth:	9"	9"	9"
Overall Height:	5"	5"	5"



No. 365 shown in #63 Gristmill Finish 60" length.

## Lexington No. 496

Available in Pine Wood

Available Unfinished, paint and stain grade: 60" and 72" lengths and #50 Medium Rustic Distressed Finish: 60" and 72" lengths.

	496-60	496-72
Top Shelf length:	60"	72"
Top Shelf Depth:	10"	10"
Bottom Base length:	60"	72"
Bottom Base Depth:	10"	10"
Overall Height:	8"	8"



No. 496 shown in #50 Medium Rustic Distressed Finish 60" length.

## Acacia No. 492

Available in Natural Finish or Weathered Finish. 48", 60", and 72" lengths.

Please Note: As each piece of Acacia wood has weathered and grown differently, wood colors, cracks, and knots can vary greatly from photographs, and from one piece to the next. The random character of the wood will result in an individual and unique look for each piece.

	492-48	492-60	492-72
Top Shelf length:	48"	60"	72"
Top Shelf Depth:	9"	9"	9"
Overall Height:	5"	5"	5"

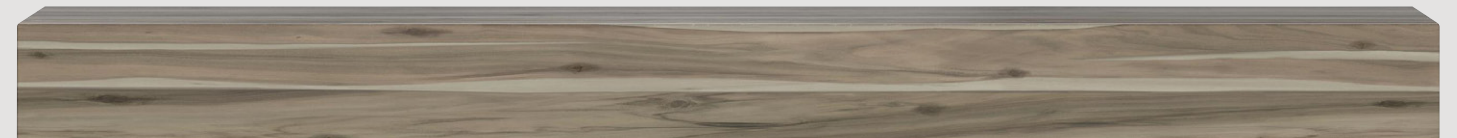

No. 492 shown in Weathered Finish 60" length.



No. 492 shown in Natural Finish 60" length.

Because each mounting surface is different, hardware is not included to attach the hanger board to the mounting surface. Please consult a professional for advice.

#### WARNING! HEAT CLEARANCES MUST BE ADHERED TO

FOR INSTALLATION OF THIS PRODUCT; ADHERE TO YOUR LOCAL BUILDING HEAT CLEARANCE CODES AND HEAT CLEARANCES AS STATED BY THE MANUFACTURER OF YOUR SPECIFIC FIREBOX OR STOVE MODEL. FAILURE TO DO SO WILL VOID THE PRODUCT WARRANTY. ALWAYS CONSULT A PROFESSIONAL.

Product lifestyle photos and drawings are for illustration only. For all surrounds and shelves: hardware is not included to attach the hanger board to the mounting surface.

\*All Pearl Mantels are manufactured individually. Measurements listed are standard, but tolerances may vary. We encourage you to measure your mantel prior to installation and for all custom-fit applications.

Visit our website for more photos and information on our products and fine furniture quality finishes—[www.pearlmantels.com](http://www.pearlmantels.com)

Actual finish colors and distressing may vary from photos. © 1995-2023 Pearl Mantels Corporation®



# Zachary Non-Combustible Mantel!

Mantels are hand painted and hand distressed. Actual finish colors, textures and distressing may vary from photos.

All new non-combustible mantels for use indoors or out! Extremely light-weight, strong, weather-resistant and easy to hang. The paint finish is hand-applied making each piece unique in character and its own individual masterpiece. Transitional designs that fit comfortably into a contemporary or traditional setting make these mantels the perfect addition to your indoor or outdoor room. Pre-drilled metal hanger board, exclusive to this piece.

U.S. Patent No. D891,606  
and 10750857

## Zachary Non-Combustible SMOOTH

Available in Whitewash or Graywash finish.  
48", 60", and 72" lengths.

NC WHITEWASH, NC GRAYWASH	NC-48	NC-60	NC-72
Top Shelf length	48"	60"	72"
Top Shelf Depth	9"	9"	9"
Bottom Base length	48"	60"	72"
Bottom Base Depth	9"	9"	9"
Overall Height	5"	5"	5"
Net Weight	26 lbs.	35 lbs.	42 lbs.

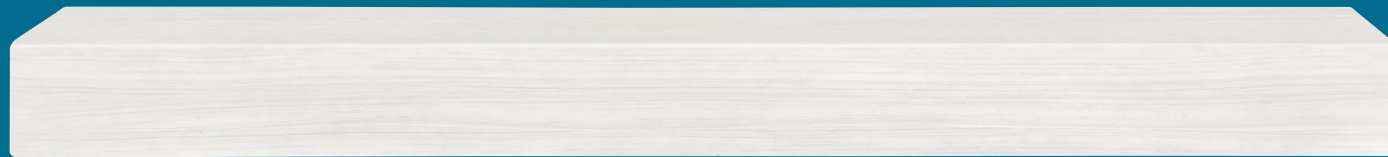

Zachary Non-Combustible shown in Whitewash Smooth finish 60" length.



Zachary Non-Combustible shown in Graywash Smooth finish 60" length.

U.S. Patent No. D891,606  
and 10750857

## Zachary Non-Combustible WOOD LOOK

Available in Little River finish.  
48", 60", and 72" lengths.

NC LITRIVER	NC-48	NC-60	NC-72
Top Shelf length	48"	60"	72"
Top Shelf Depth	7.87"	7.87"	7.87"
Bottom Base length	48"	60"	72"
Bottom Base Depth	7.87"	7.87"	7.87"
Overall Height	5"	5"	5"
Net Weight	21 lbs.	26 lbs.	30 lbs.

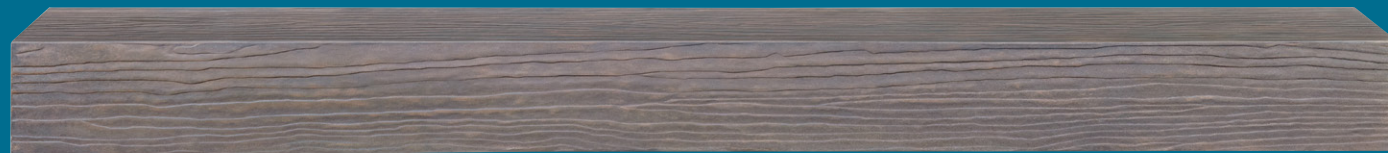

Zachary Non-Combustible shown in Little River Wood Look finish 60" length.



Unique pre-drilled hanger rail included for installation in all finishes.

**WARNING! HEAT CLEARANCES MUST BE ADHERED TO** FOR INSTALLATION OF THIS PRODUCT; ADHERE TO YOUR LOCAL BUILDING HEAT CLEARANCE CODES AND HEAT CLEARANCES AS STATED BY THE MANUFACTURER OF YOUR SPECIFIC FIREBOX OR STOVE MODEL. FAILURE TO DO SO WILL VOID THE PRODUCT WARRANTY. ALWAYS CONSULT A PROFESSIONAL.

All finishes are hand applied. Each shelf is hand crafted and painted, appearance may vary from published pictures.

Because each mounting surface is different, hardware is not included to attach the hanger board to the mounting surface. Please consult a professional for advice.

Product lifestyle photos and drawings are for illustration only. For all surrounds and shelves: hardware is not included to attach the hanger board to the mounting surface.  
\*All Pearl Mantels are manufactured individually. Measurements listed are standard, but tolerances may vary. We encourage you to measure your mantel prior to installation and for all custom-fit applications.

Visit our website for more photos and information on our products and fine furniture quality finishes—[www.pearlmanentels.com](http://www.pearlmanentels.com)

Actual finish colors and distressing may vary from photos. © 1995-2023 Pearl Mantels Corporation®

# Zachary Non-Combustible Mantel! Choose a Shelf or Surround!

Mantels are hand painted and hand distressed. Actual finish colors, textures and distressing may vary from photos.



Zachary Non-Combustible Surround shown in Salt finish.

PATENT  
PENDING

## Zachary Surround Non-Combustible SMOOTH

Available in Salt Finish.  
48" opening width.

	NCSB-48
Projection:	1.5"
Interior Width:	48"
Interior Height:	42"
Width to outside leg at base:	58"
Shelf length:	64"
Shelf Depth:	8"
Shelf Height:	5"
Overall Height:	47"
Weight:	88 lbs.

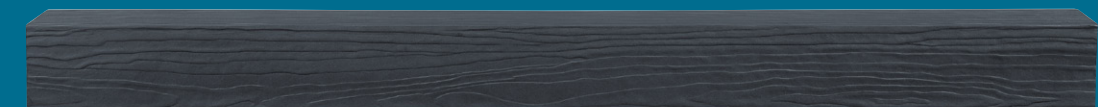

Zachary Non-Combustible Surround shown in Pepper finish.

PATENT  
PENDING

## Zachary Surround Non-Combustible WOOD LOOK

Available in Pepper Finish.  
48" and (56" while supplies last) opening widths.

	NCSW-48	NCSW-56
Projection:	1.5"	1.5"
Interior Width:	48"	56"
Interior Height:	42"	42"
Width to outside leg at base:	58"	66"
Shelf length:	64"	72"
Shelf Depth:	8"	8"
Shelf Height:	5"	5"
Overall Height:	47"	47"
Weight:	88 lbs.	100 lbs.

**WARNING! HEAT CLEARANCES MUST BE ADHERED TO** FOR INSTALLATION OF THIS PRODUCT; ADHERE TO YOUR LOCAL BUILDING HEAT CLEARANCE CODES AND HEAT CLEARANCES AS STATED BY THE MANUFACTURER OF YOUR SPECIFIC FIREBOX OR STOVE MODEL. FAILURE TO DO SO WILL VOID THE PRODUCT WARRANTY. ALWAYS CONSULT A PROFESSIONAL.

Because each mounting surface is different, hardware is not included to attach the hanger board to the mounting surface. Please consult a professional for advice.

Product lifestyle photos and drawings are for illustration only. For all surrounds and shelves: hardware is not included to attach the hanger board to the mounting surface.  
\*All Pearl Mantels are manufactured individually. Measurements listed are standard, but tolerances may vary. We encourage you to measure your mantel prior to installation and for all custom-fit applications.

Visit our website for more photos and information on our products and fine furniture quality finishes—[www.pearlmanentels.com](http://www.pearlmanentels.com)

Actual finish colors and distressing may vary from photos. © 1995-2023 Pearl Mantels Corporation®

# MDF—The perfect blend of design and price!

Mantels are hand painted and hand distressed. Actual finish colors, textures and distressing may vary from photos.



No. 618 Crestwood MDF shown in White painted finish 60" length.

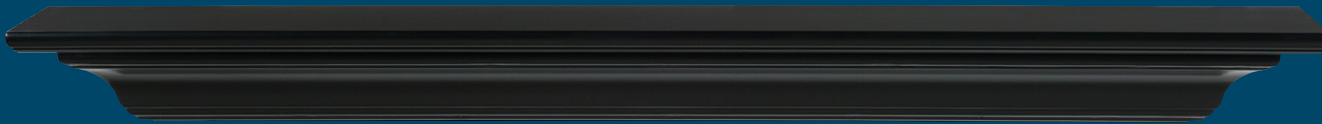

No. 618 Crestwood MDF shown in Black painted finish 60" length.

## Crestwood No. 618

MDF Available in White and Black painted finish in 48", 60", and 72" lengths.

	618-48	618-60	618-72
Top Shelf length:	48"	60"	72"
Top Shelf Depth:	10"	10"	10"
Bottom Base length:	39"	51"	63"
Bottom Base Depth:	5.5"	5.5"	5.5"
Overall Height:	5"	5"	5"

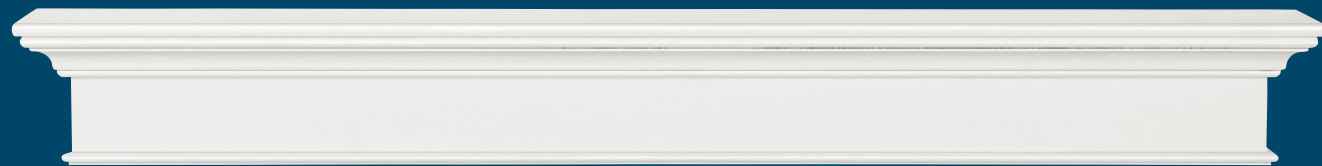

No. 610 Henry MDF shown in White painted finish 60" length.

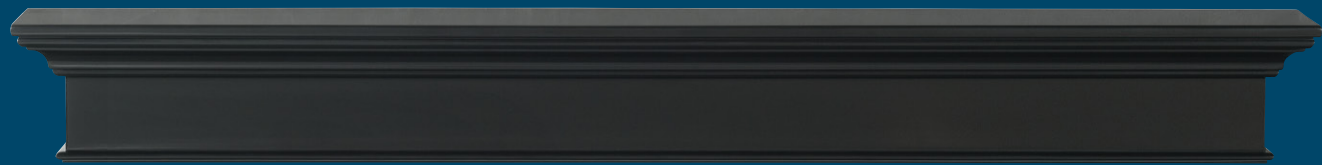

No. 610 Henry MDF shown in Black painted finish 60" length.

## Henry No. 610

MDF Available in White or Black painted finish. 48", 60", and 72" lengths.

	610-48	610-60	610-72
Top Shelf length:	48"	60"	72"
Top Shelf Depth:	9"	9"	9"
Bottom Base length:	43.75"	55.875"	67.75"
Bottom Base Depth:	6.875"	6.875"	6.875"
Overall Height:	8"	8"	8"

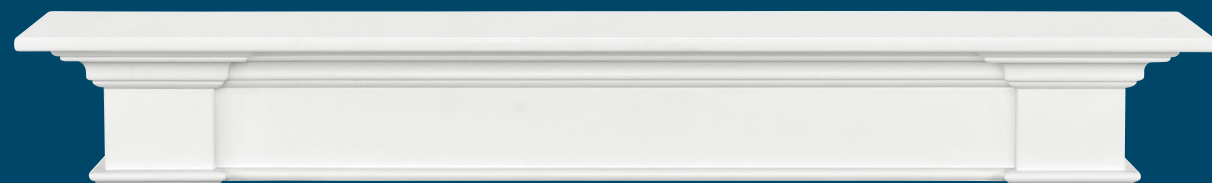

No. 614 Shepherd MDF shown in White painted finish 60" length.

## Shepherd No. 614

MDF Available in White painted finish. 48", 60", and 72" lengths.

	614-48	614-60	614-72
Top Shelf length:	48"	60"	72"
Top Shelf Depth:	11"	11"	11"
Bottom Base length:	41.75"	53.75"	65.75"
Bottom Base Depth:	7.75"	7.75"	7.75"
Overall Height:	8"	8"	8"

Because each mounting surface is different, hardware is not included to attach the hanger board to the mounting surface. Please consult a professional for advice.

# Your Mantel Headquarters!

Mantels are hand painted and hand distressed. Actual finish colors, textures and distressing may vary from photos.

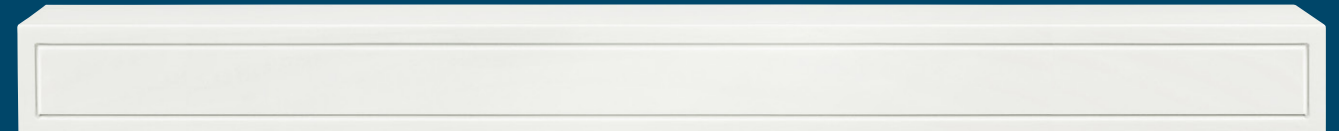

No. 612 Sarah MDF shown in White painted finish 60" length.

## Sarah No. 612

U.S. Patent No. D845,466 S  
MDF Available in White painted finish. 48", 60", and 72" lengths.

	612-48	612-60	612-72
Top Shelf length:	48"	60"	72"
Top Shelf Depth:	9"	9"	9"
Bottom Base length:	48"	60"	72"
Bottom Base Depth:	9"	9"	9"
Overall Height:	5"	5"	5"

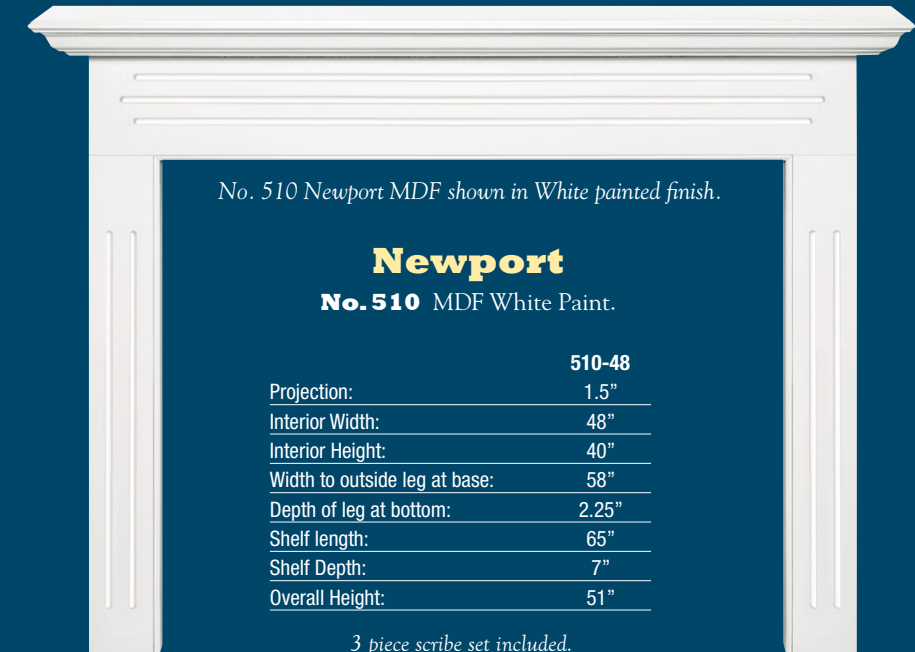

No. 510 Newport MDF shown in White painted finish.

## Newport

No. 510 MDF White Paint.

	510-48
Projection:	1.5"
Interior Width:	48"
Interior Height:	40"
Width to outside leg at base:	58"
Depth of leg at bottom:	2.25"
Shelf length:	65"
Shelf Depth:	7"
Overall Height:	51"

3 piece scribe set included.

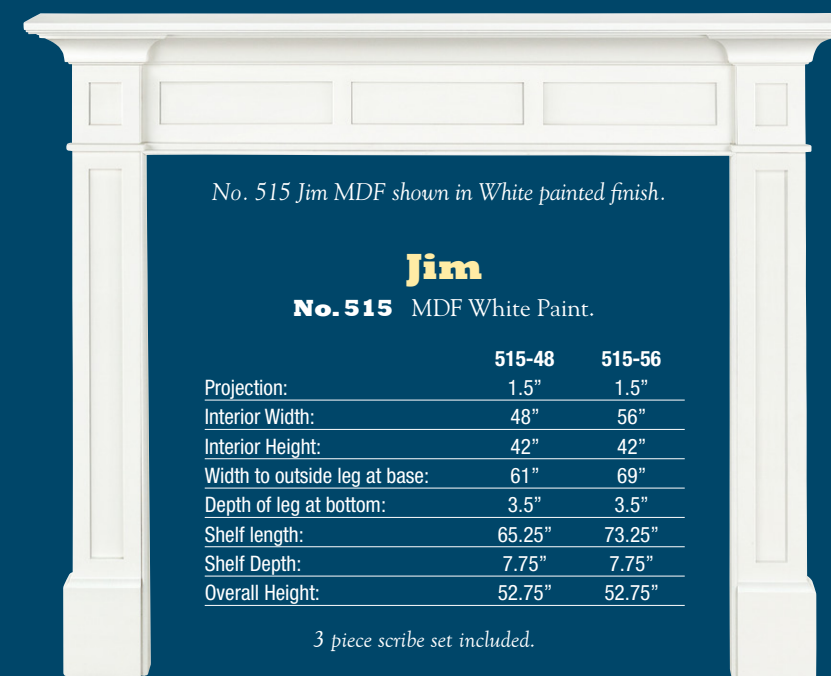

No. 515 Jim MDF shown in White painted finish.

## Jim

No. 515 MDF White Paint.

	515-48	515-56
Projection:	1.5"	1.5"
Interior Width:	48"	56"
Interior Height:	42"	42"
Width to outside leg at base:	61"	69"
Depth of leg at bottom:	3.5"	3.5"
Shelf length:	65.25"	73.25"
Shelf Depth:	7.75"	7.75"
Overall Height:	52.75"	52.75"

3 piece scribe set included.

Because each mounting surface is different, hardware is not included to attach the hanger board to the mounting surface. Please consult a professional for advice.



## LOOK FOR THE PEARL!

Each of our pieces is lovingly branded with a Pearl inlay—Our Certificate of Authenticity.

**WARNING! HEAT CLEARANCES MUST BE ADHERED TO FOR INSTALLATION OF THIS PRODUCT; ADHERE TO YOUR LOCAL BUILDING HEAT CLEARANCE CODES AND HEAT CLEARANCES AS STATED BY THE MANUFACTURER OF YOUR SPECIFIC FIREBOX OR STOVE MODEL. FAILURE TO DO SO WILL VOID THE PRODUCT WARRANTY. ALWAYS CONSULT A PROFESSIONAL.**

Product lifestyle photos and drawings are for illustration only. For all surrounds and shelves: hardware is not included to attach the hanger board to the mounting surface.

\*All Pearl Mantels are manufactured individually. Measurements listed are standard, but tolerances may vary. We encourage you to measure your mantel prior to installation and for all custom-fit applications.

Visit our website for more photos and information on our products and fine furniture quality finishes—[www.pearlmanentels.com](http://www.pearlmanentels.com)

Actual finish colors and distressing may vary from photos. © 1995-2023 Pearl Mantels Corporation®

**WARNING! HEAT CLEARANCES MUST BE ADHERED TO FOR INSTALLATION OF THIS PRODUCT; ADHERE TO YOUR LOCAL BUILDING HEAT CLEARANCE CODES AND HEAT CLEARANCES AS STATED BY THE MANUFACTURER OF YOUR SPECIFIC FIREBOX OR STOVE MODEL. FAILURE TO DO SO WILL VOID THE PRODUCT WARRANTY. ALWAYS CONSULT A PROFESSIONAL.**

Product lifestyle photos and drawings are for illustration only. For all surrounds and shelves: hardware is not included to attach the hanger board to the mounting surface.

\*All Pearl Mantels are manufactured individually. Measurements listed are standard, but tolerances may vary. We encourage you to measure your mantel prior to installation and for all custom-fit applications.

Visit our website for more photos and information on our products and fine furniture quality finishes—[www.pearlmanentels.com](http://www.pearlmanentels.com)

Actual finish colors and distressing may vary from photos. © 1995-2023 Pearl Mantels Corporation®



# MDF—The perfect blend of design and price!

Mantels are hand painted and hand distressed. Actual finish colors, textures and distressing may vary from photos.

# Your Mantel Headquarters!

Mantels are hand painted and hand distressed. Actual finish colors, textures and distressing may vary from photos.

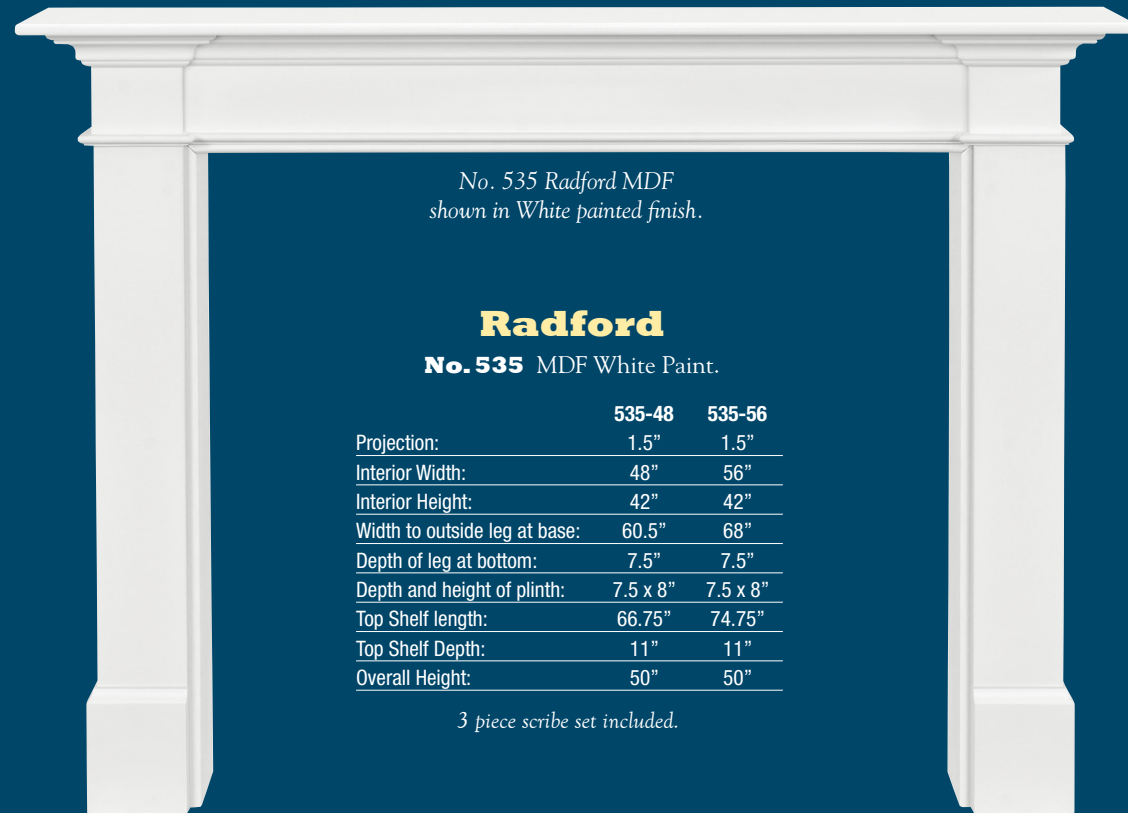

No. 535 Radford MDF  
shown in White painted finish.

## Radford

No. 535 MDF White Paint.

	535-48	535-56
Projection:	1.5"	1.5"
Interior Width:	48"	56"
Interior Height:	42"	42"
Width to outside leg at base:	60.5"	68"
Depth of leg at bottom:	7.5"	7.5"
Depth and height of plinth:	7.5 x 8"	7.5 x 8"
Top Shelf length:	66.75"	74.75"
Top Shelf Depth:	11"	11"
Overall Height:	50"	50"

3 piece scribe set included.



No. 540 Marshall MDF  
shown in White painted finish.

## Marshall

No. 540 MDF White Paint.

	540-48	540-56
Projection:	1.5"	1.5"
Interior Width:	48"	56"
Interior Height:	42"	42"
Width to outside leg at base:	66"	74"
Depth of leg at bottom:	4"	4"
Shelf length:	72"	80"
Shelf Depth:	8"	8"
Overall Height:	54"	54"

3 piece scribe set included.



No. 525 Mike MDF shown in White painted finish.

## Mike

No. 525 MDF White Paint.

	525-48
Projection:	1.5"
Interior Width:	48"
Interior Height:	42"
Width to outside leg at base:	60"
Depth of leg at bottom:	3"
Shelf length:	64"
Shelf Depth:	7.87"
Overall Height:	52.36"

3 piece scribe set included.

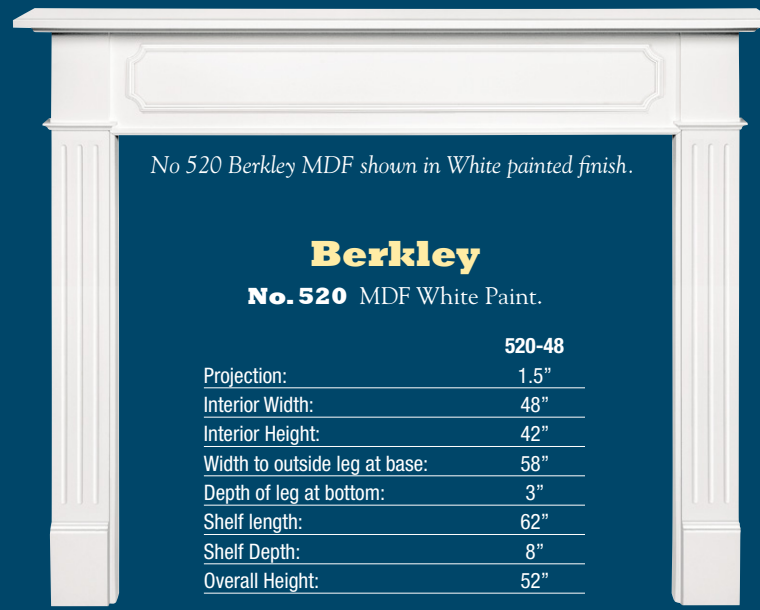

No. 520 Berkley MDF shown in White painted finish.

## Berkley

No. 520 MDF White Paint.

	520-48
Projection:	1.5"
Interior Width:	48"
Interior Height:	42"
Width to outside leg at base:	58"
Depth of leg at bottom:	3"
Shelf length:	62"
Shelf Depth:	8"
Overall Height:	52"

3 piece scribe set included.



## LOOK FOR THE PEARL!

Each of our pieces is lovingly branded with a Pearl inlay—Our Certificate of Authenticity.

No. 550 MDF shown in White painted finish.

Because each mounting surface is different, hardware is *not* included to attach the hanger board to the mounting surface. Please consult a professional for advice.

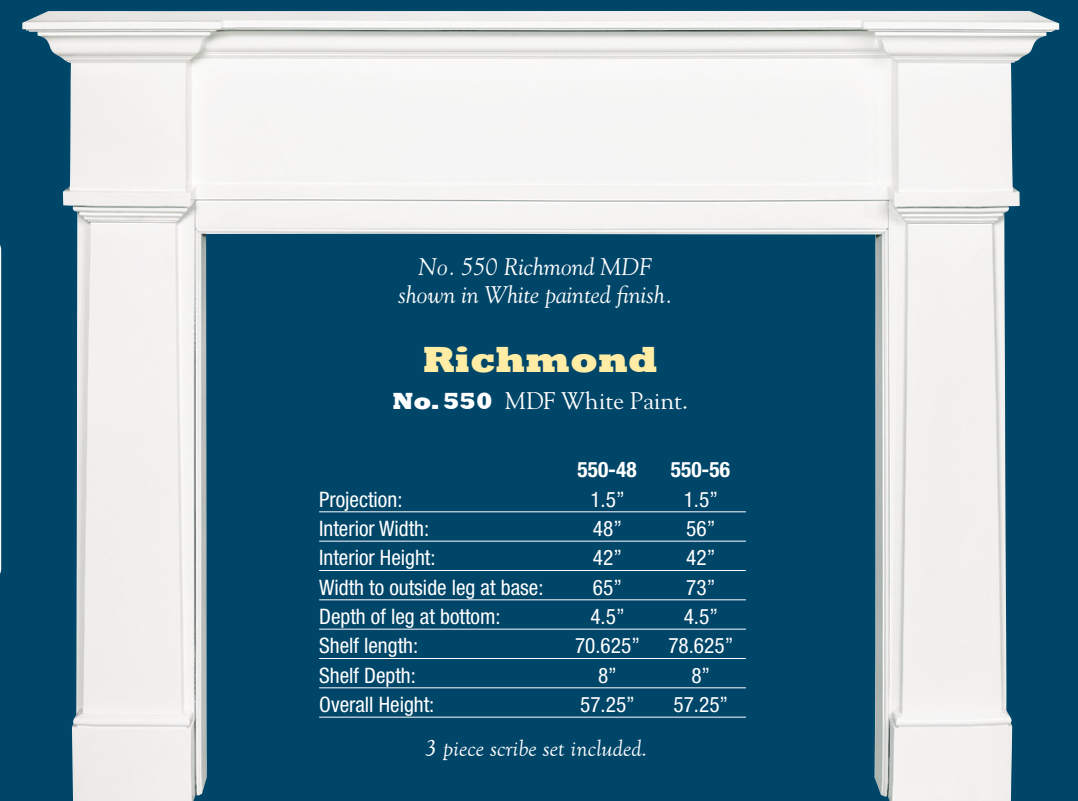

No. 550 Richmond MDF  
shown in White painted finish.

## Richmond

No. 550 MDF White Paint.

	550-48	550-56
Projection:	1.5"	1.5"
Interior Width:	48"	56"
Interior Height:	42"	42"
Width to outside leg at base:	65"	73"
Depth of leg at bottom:	4.5"	4.5"
Shelf length:	70.625"	78.625"
Shelf Depth:	8"	8"
Overall Height:	57.25"	57.25"

3 piece scribe set included.

Because each mounting surface is different, hardware is *not* included to attach the hanger board to the mounting surface. Please consult a professional for advice.

**WARNING! HEAT CLEARANCES MUST BE ADHERED TO FOR INSTALLATION OF THIS PRODUCT; ADHERE TO YOUR LOCAL BUILDING HEAT CLEARANCE CODES AND HEAT CLEARANCES AS STATED BY THE MANUFACTURER OF YOUR SPECIFIC FIREBOX OR STOVE MODEL. FAILURE TO DO SO WILL VOID THE PRODUCT WARRANTY. ALWAYS CONSULT A PROFESSIONAL.**

Product lifestyle photos and drawings are for illustration only. For all surrounds and shelves: hardware is *not* included to attach the hanger board to the mounting surface.

\*All Pearl Mantels are manufactured individually. Measurements listed are standard, but tolerances may vary. We encourage you to measure your mantel prior to installation and for all custom-fit applications.

Visit our website for more photos and information on our products and fine furniture quality finishes—[www.pearlmanentels.com](http://www.pearlmanentels.com)

Actual finish colors and distressing may vary from photos. © 1995-2023 Pearl Mantels Corporation®

**WARNING! HEAT CLEARANCES MUST BE ADHERED TO FOR INSTALLATION OF THIS PRODUCT; ADHERE TO YOUR LOCAL BUILDING HEAT CLEARANCE CODES AND HEAT CLEARANCES AS STATED BY THE MANUFACTURER OF YOUR SPECIFIC FIREBOX OR STOVE MODEL. FAILURE TO DO SO WILL VOID THE PRODUCT WARRANTY. ALWAYS CONSULT A PROFESSIONAL.**

Product lifestyle photos and drawings are for illustration only. For all surrounds and shelves: hardware is *not* included to attach the hanger board to the mounting surface.

\*All Pearl Mantels are manufactured individually. Measurements listed are standard, but tolerances may vary. We encourage you to measure your mantel prior to installation and for all custom-fit applications.

Visit our website for more photos and information on our products and fine furniture quality finishes—[www.pearlmanentels.com](http://www.pearlmanentels.com)

Actual finish colors and distressing may vary from photos. © 1995-2023 Pearl Mantels Corporation®



# Flexible Space Solutions!

Mantels are hand painted and hand distressed. Actual finish colors, textures and distressing may vary from photos.

The Emory Contemporary Surround and Emory Contemporary Shelf are truly “One Size Fits All!”  
The surround is adjustable in height and width, and the shelf is adjustable in width.

## Emory Contemporary Surround

**No. 201 Expandable Height and Width** MDF Available in White Paint.

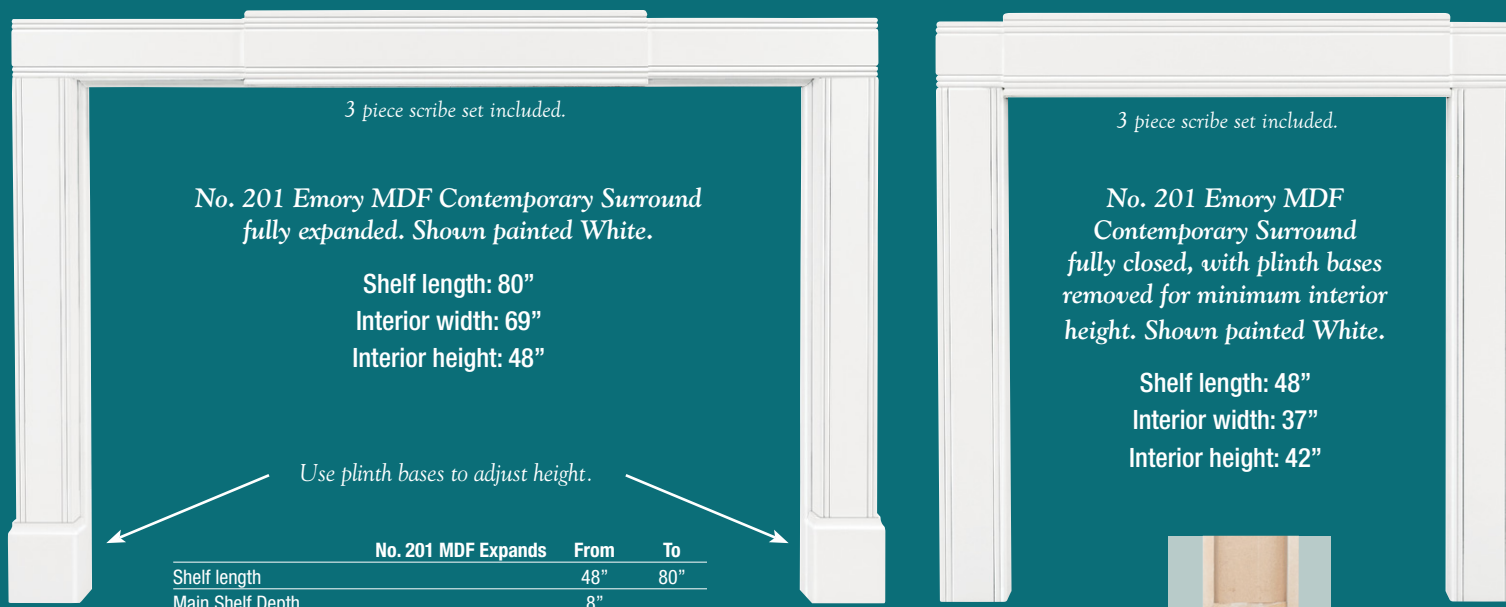

3 piece scribe set included.

No. 201 Emory MDF Contemporary Surround fully expanded. Shown painted White.

Shelf length: 80"  
Interior width: 69"  
Interior height: 48"

3 piece scribe set included.

No. 201 Emory MDF Contemporary Surround fully closed, with plinth bases removed for minimum interior height. Shown painted White.

Shelf length: 48"  
Interior width: 37"  
Interior height: 42"

Use plinth bases to adjust height.

No. 201 MDF Expands	From	To
Shelf length	48"	80"
Main Shelf Depth	8"	
Shelf Depth of expanded wings	7.5"	
Interior Width	37"	69"
Interior Height	42"	48"
Overall Height	49"	55"
Leg width without added plinth	5.5"	
Leg width with plinth added	7"	
Plinth height	8"	
Plinth depth	7.875"	
Outside leg to outside leg at base without plinth	48"	80"
Outside leg to outside leg at base with plinth	51"	83"

3 piece scribe set included.

Because each mounting surface is different, hardware is not included to attach the hanger board to the mounting surface. Please consult a professional for advice.



No. 201 MDF rear view of plinth base showing adjustable height feature. Plinth is used for increasing the mantel height.

## Emory Contemporary Shelf

**No. 211 Expandable Width** MDF Available in White Paint.

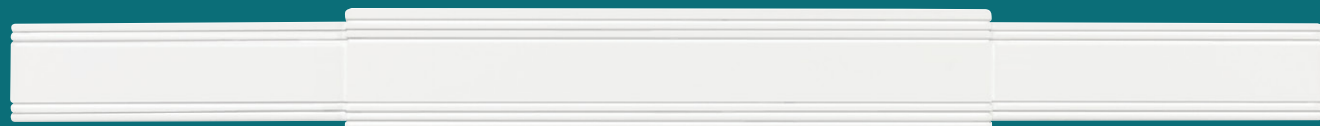

No. 211 Emory MDF Contemporary Shelf fully expanded. Shown painted White.

No. 211 Expands	From	To
Shelf length	48"	80"
Main shelf depth	8"	
Shelf Depth of expanded wings	7.5"	
Main shelf height	8"	
Shelf height of expanded wings	5.5"	

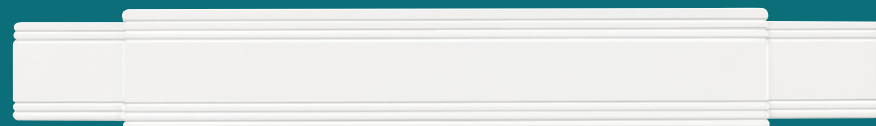

No. 211 Emory MDF Contemporary Shelf fully closed. Shown painted White.

### WARNING! HEAT CLEARANCES MUST BE ADHERED TO

FOR INSTALLATION OF THIS PRODUCT; ADHERE TO YOUR LOCAL BUILDING HEAT CLEARANCE CODES AND HEAT CLEARANCES AS STATED BY THE MANUFACTURER OF YOUR SPECIFIC FIREBOX OR STOVE MODEL. FAILURE TO DO SO WILL VOID THE PRODUCT WARRANTY. ALWAYS CONSULT A PROFESSIONAL.

Product lifestyle photos and drawings are for illustration only. For all surrounds and shelves: hardware is not included to attach the hanger board to the mounting surface.

\*All Pearl Mantels are manufactured individually. Measurements listed are standard, but tolerances may vary. We encourage you to measure your mantel prior to installation and for all custom-fit applications.

Visit our website for more photos and information on our products and fine furniture quality finishes—[www.pearlmanentels.com](http://www.pearlmanentels.com)

Actual finish colors and distressing may vary from photos. © 1995-2023 Pearl Mantels Corporation®

# Classic Shelf Designs

Mantels are hand painted and hand distressed. Actual finish colors, textures and distressing may vary from photos.



No. 490 Lindon shown in #70 Cherry Distressed Finish 60" length.

## Lindon No. 490

Unfinished, paint and stain grade: 60" and 72" lengths.  
#70 Cherry Distressed Finish: 48", 60", and 72" lengths.

	490-48	490-60	490-72
Top Shelf length:	48"	60"	72"
Top Shelf Depth:	8"	10"	10"
Bottom Base length:	42"	54"	66"
Bottom Base Depth:	5"	7"	7"
Overall Height:	6.5"	7"	7"



No. 490 Shown in #70 Cherry Distressed Finish.

### LOOK FOR THE PEARL!

Each of our pieces is lovingly branded with a Pearl inlay—Our Certificate of Authenticity.

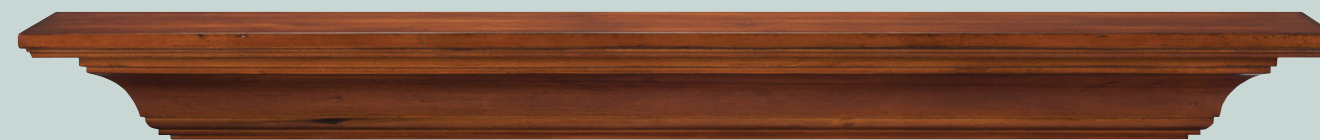

No. 418 Homestead shown in #90 Antique Finish 60" length.

## Homestead No. 418

Unfinished, paint and stain grade: 60" and 72" lengths.  
#90 Antique Finish: 48", 60", and 72" lengths.

	418-48	418-60	418-72
Top Shelf length:	48"	60"	72"
Top Shelf Depth:	10"	10"	10"
Bottom Base length:	38"	50"	62"
Bottom Base Depth:	4.625"	4.625"	4.625"
Overall Height:	5"	5"	5"



No. 416 Devonshire shown in #70 Cherry Distressed Finish 60" length.

## Devonshire No. 416

Available Unfinished, paint and stain grade in 60" and 72" lengths, or #70 Cherry Distressed Finish in 60" and 72" lengths. Install with or without corbels.

	416-60	416-72
Top Shelf length:	60"	72"
Top Shelf Depth:	10"	10"
Bottom Base length:	48.5"	60.5"
Bottom Base Depth:	5.375"	5.375"
Distance between Corbels:	40"	52"
Width of each Corbel:	4"	4"
Overall Height without Corbels:	9"	9"
Overall Height with Corbels:	16.75"	16.75"



420 Savannah shown in #15 Taos Finish 60" length.

## Savannah No. 420

Pine and Pine Veneer. 48", 60", and 72" lengths.  
Available Unfinished, paint and stain grade, and in #15 Taos Finish.

	420-48	420-60	420-72
Top Shelf length:	48"	60"	72"
Top Shelf Depth:	9"	9"	9"
Bottom Base length:	43"	55"	67"
Bottom Base Depth:	6.5"	6.5"	6.5"
Overall Height:	9"	9"	9"

Because each mounting surface is different, hardware is not included to attach the hanger board to the mounting surface. Please consult a professional for advice.

### WARNING! HEAT CLEARANCES MUST BE ADHERED TO

FOR INSTALLATION OF THIS PRODUCT; ADHERE TO YOUR LOCAL BUILDING HEAT CLEARANCE CODES AND HEAT CLEARANCES AS STATED BY THE MANUFACTURER OF YOUR SPECIFIC FIREBOX OR STOVE MODEL. FAILURE TO DO SO WILL VOID THE PRODUCT WARRANTY. ALWAYS CONSULT A PROFESSIONAL.

Product lifestyle photos and drawings are for illustration only. For all surrounds and shelves: hardware is not included to attach the hanger board to the mounting surface.

\*All Pearl Mantels are manufactured individually. Measurements listed are standard, but tolerances may vary. We encourage you to measure your mantel prior to installation and for all custom-fit applications.

Visit our website for more photos and information on our products and fine furniture quality finishes—[www.pearlmanentels.com](http://www.pearlmanentels.com)

Actual finish colors and distressing may vary from photos. © 1995-2023 Pearl Mantels Corporation®



# DESIGNED FOR VERSATILITY!

Mantels are hand painted and hand distressed. Actual finish colors, textures and distressing may vary from photos.

## The Auburn, Hadley and Celeste offer three design choices!

You have the option of installing just the shelf, the shelf with corbels, or the complete combination of shelf, corbels, and arch.

### 3 HANGING OPTIONS!

Included: Arch, Corbels and Shelf.

Shelf Only



497 Celeste shown in #20 Espresso Distressed Finish 60" length with shelf only.

Shelf with Corbels



497 Celeste shown in #20 Espresso Distressed Finish 60" length with shelf and corbels.

Shelf with Corbels and Arch

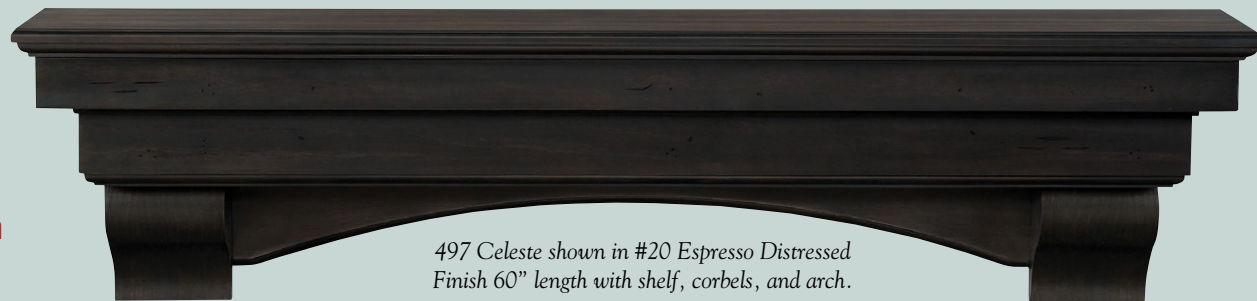

497 Celeste shown in #20 Espresso Distressed Finish 60" length with shelf, corbels, and arch.

#### Specifications for 495, 497 and 499

	48	60	72
Top Shelf length:	48"	60"	72"
Top Shelf Depth:	9.5"	10"	10"
Bottom Base length:	42.5"	52.5"	64.5"
Bottom Base Depth:	6"	6"	6"
Distance Between Corbels:	31"	40.5"	52.5"
Width Of Each Corbel:	4.75"	6"	6"
Height Of Each Corbel:	5.625"	6.75"	6.75"
Overall Height With Corbel:	12"	15"	15"
Radius:	43.375"	58.625"	99.75"



**LOOK FOR THE PEARL!**

Each of our pieces is lovingly branded with a Pearl inlay—Our Certificate of Authenticity.

No. 495 Auburn Shown in #70 Cherry Distressed Finish.

Because each mounting surface is different, hardware is not included to attach the hanger board to the mounting surface. Please consult a professional for advice.

#### WARNING! HEAT CLEARANCES MUST BE ADHERED TO

FOR INSTALLATION OF THIS PRODUCT; ADHERE TO YOUR LOCAL BUILDING HEAT CLEARANCE CODES AND HEAT CLEARANCES AS STATED BY THE MANUFACTURER OF YOUR SPECIFIC FIREBOX OR STOVE MODEL. FAILURE TO DO SO WILL VOID THE PRODUCT WARRANTY. ALWAYS CONSULT A PROFESSIONAL.

Product lifestyle photos and drawings are for illustration only. For all surrounds and shelves: hardware is not included to attach the hanger board to the mounting surface.

\*All Pearl Mantels are manufactured individually. Measurements listed are standard, but tolerances may vary. We encourage you to measure your mantel prior to installation and for all custom-fit applications.

Visit our website for more photos and information on our products and fine furniture quality finishes—[www.pearlmantels.com](http://www.pearlmantels.com)

Actual finish colors and distressing may vary from photos. © 1995-2023 Pearl Mantels Corporation®

# 3 Design Choices: 495 Auburn, 499 Hadley and 497 Celeste!

Mantels are hand painted and hand distressed. Actual finish colors, textures and distressing may vary from photos.

## NEW LOOK DISTRESSED FINISH!

#10 Dune Distressed and #20 Espresso Distressed

### Celeste No. 497

Pine and Pine Veneer. 48", 60", and 72" lengths. Available only in #10 Dune or #20 Espresso Finish.



No. 497 shown in #10 Dune Distressed Finish 60" length.

Shelf with Corbels and Arch



No. 497 shown in #20 Espresso Distressed Finish 60" length.

Shelf with Corbels

### Auburn No. 495

Available Unfinished, paint and stain grade: 48", 60", and 72" lengths. #70 Cherry Distressed Finish: 48", 60", and 72" lengths.



No. 495 shown in #70 Cherry Distressed Finish 60" length.

Shelf with Corbels and Arch

### Hadley No. 499

48", 60", and 72" lengths. Available only in #27 Cottage Finish with Chalk Wash Top.

The top has a chalk patina that will naturally fade into the distressing over time.

Because each mounting surface is different, hardware is not included to attach the hanger board to the mounting surface. Please consult a professional for advice.

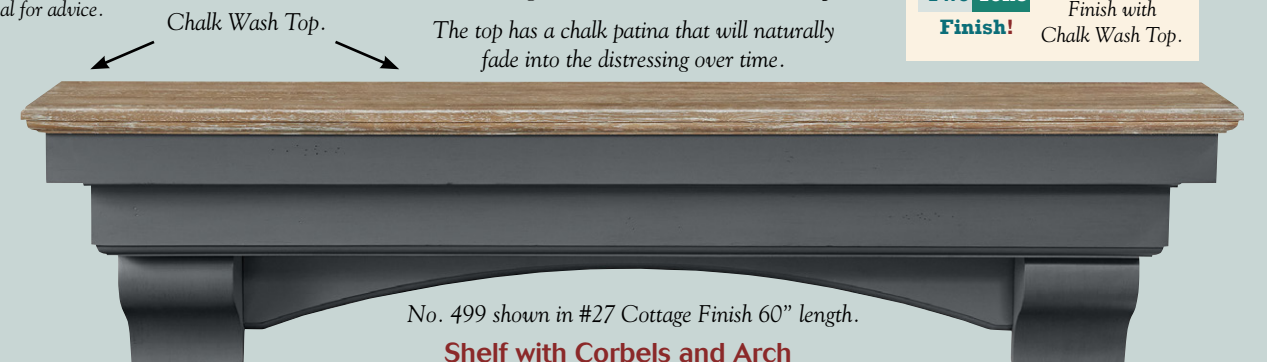

No. 499 shown in #27 Cottage Finish 60" length.

Shelf with Corbels and Arch

**Two Tone Finish!**

#27 Cottage Finish with Chalk Wash Top.

#### WARNING! HEAT CLEARANCES MUST BE ADHERED TO

FOR INSTALLATION OF THIS PRODUCT; ADHERE TO YOUR LOCAL BUILDING HEAT CLEARANCE CODES AND HEAT CLEARANCES AS STATED BY THE MANUFACTURER OF YOUR SPECIFIC FIREBOX OR STOVE MODEL. FAILURE TO DO SO WILL VOID THE PRODUCT WARRANTY. ALWAYS CONSULT A PROFESSIONAL.

Product lifestyle photos and drawings are for illustration only. For all surrounds and shelves: hardware is not included to attach the hanger board to the mounting surface.

\*All Pearl Mantels are manufactured individually. Measurements listed are standard, but tolerances may vary. We encourage you to measure your mantel prior to installation and for all custom-fit applications.

Visit our website for more photos and information on our products and fine furniture quality finishes—[www.pearlmantels.com](http://www.pearlmantels.com)

Actual finish colors and distressing may vary from photos. © 1995-2023 Pearl Mantels Corporation®



# It's the first piece of furniture in any home...

Mantels are hand painted and hand distressed. Actual finish colors, textures and distressing may vary from photos.

# Your Mantel Headquarters!

Mantels are hand painted and hand distressed. Actual finish colors, textures and distressing may vary from photos.

**LOOK FOR THE PEARL!**

Each of our pieces is lovingly branded with a Pearl inlay—Our Certificate of Authenticity.

No. 110 shown Unfinished.

Because each mounting surface is different, hardware is not included to attach the hanger board to the mounting surface. Please consult a professional for advice.

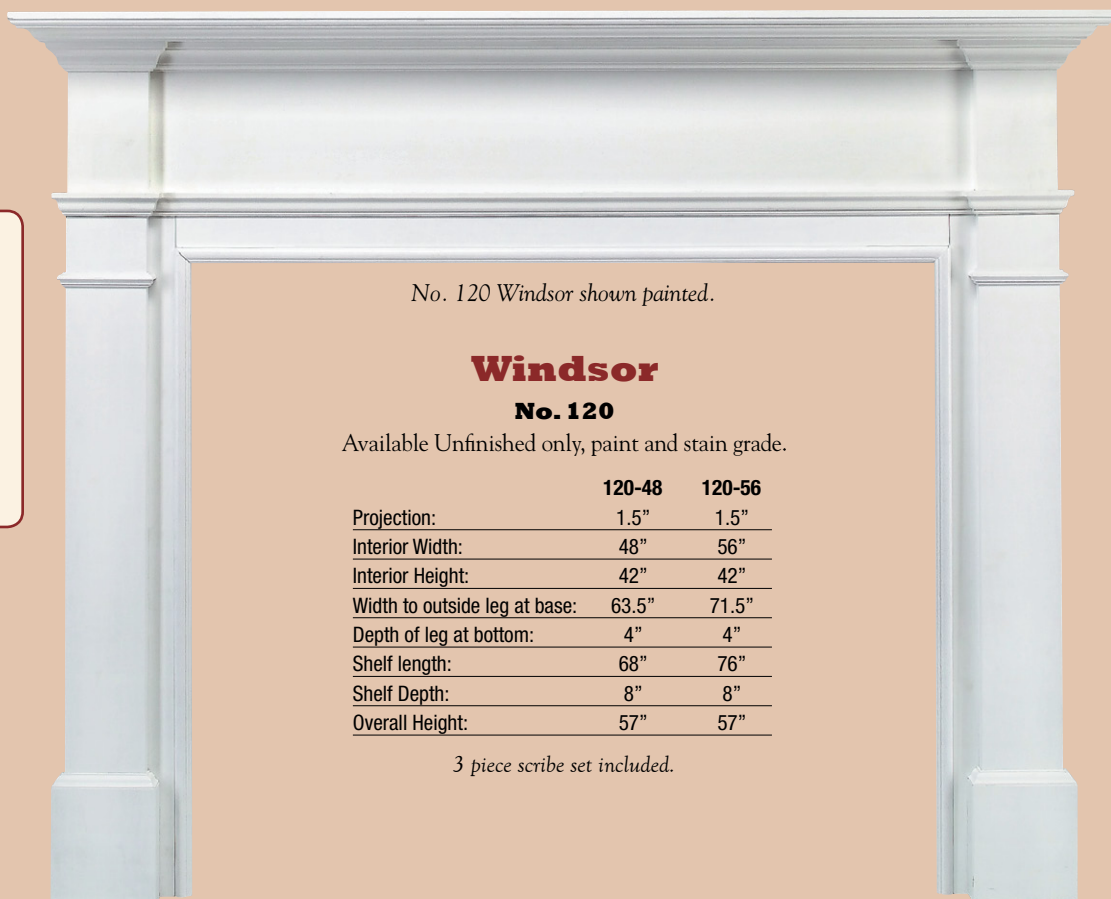

No. 120 Windsor shown painted.

## Windsor No. 120

Available Unfinished only, paint and stain grade.

	120-48	120-56
Projection:	1.5"	1.5"
Interior Width:	48"	56"
Interior Height:	42"	42"
Width to outside leg at base:	63.5"	71.5"
Depth of leg at bottom:	4"	4"
Shelf length:	68"	76"
Shelf Depth:	8"	8"
Overall Height:	57"	57"

3 piece scribe set included.

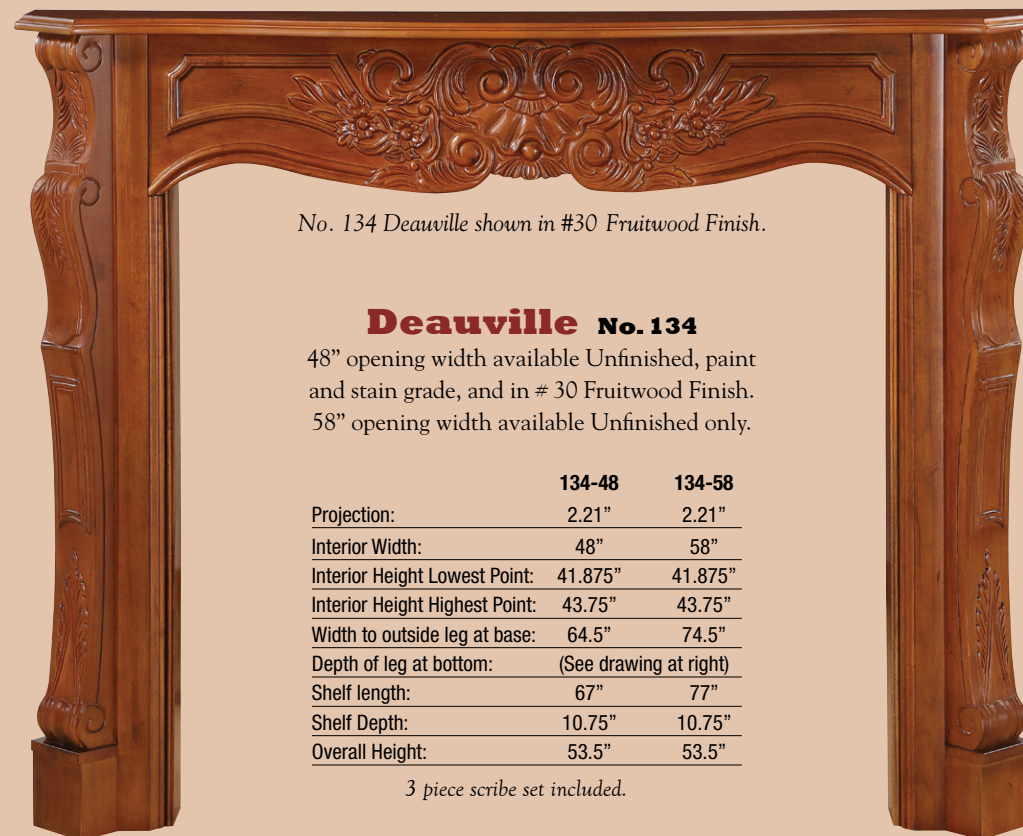

No. 134 Deauville shown in #30 Fruitwood Finish.

## Deauville No. 134

48" opening width available Unfinished, paint and stain grade, and in # 30 Fruitwood Finish.  
58" opening width available Unfinished only.

	134-48	134-58
Projection:	2.21"	2.21"
Interior Width:	48"	58"
Interior Height Lowest Point:	41.875"	41.875"
Interior Height Highest Point:	43.75"	43.75"
Width to outside leg at base:	64.5"	74.5"
Depth of leg at bottom:	(See drawing at right)	
Shelf length:	67"	77"
Shelf Depth:	10.75"	10.75"
Overall Height:	53.5"	53.5"

3 piece scribe set included.

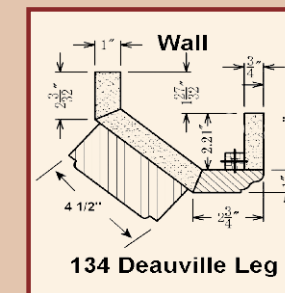

Detail of No. 134 Deauville Leg.

Because each mounting surface is different, hardware is not included to attach the hanger board to the mounting surface. Please consult a professional for advice.

## Easy Assembly

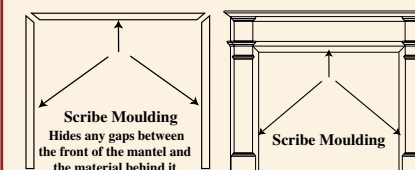
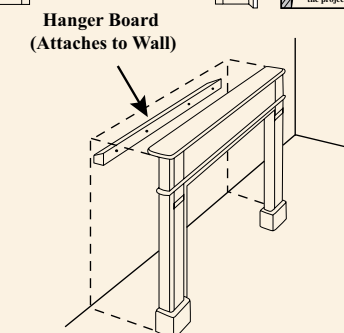
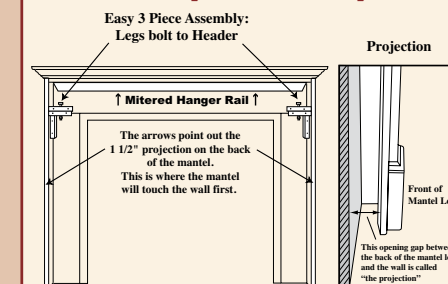

Note: Mounting hardware for hanger board and scribe moldings are not included.

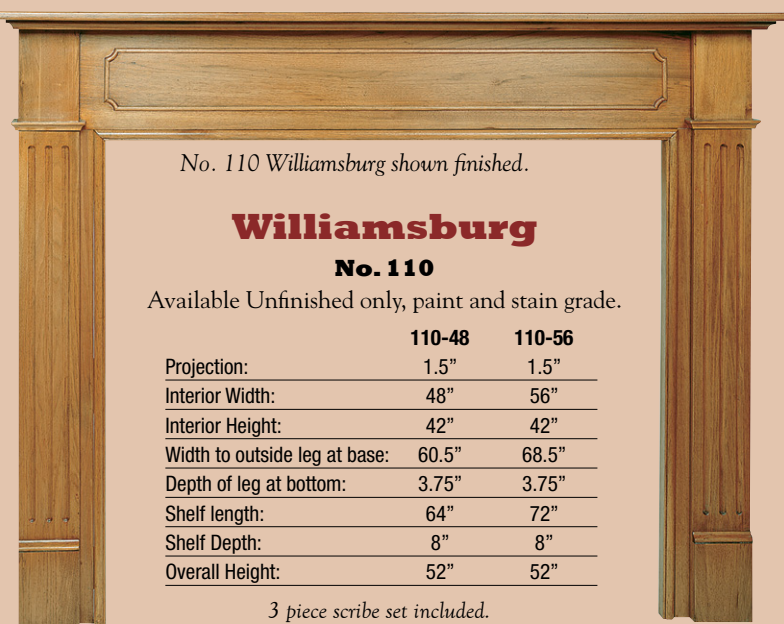

No. 110 Williamsburg shown finished.

## Williamsburg No. 110

Available Unfinished only, paint and stain grade.

	110-48	110-56
Projection:	1.5"	1.5"
Interior Width:	48"	56"
Interior Height:	42"	42"
Width to outside leg at base:	60.5"	68.5"
Depth of leg at bottom:	3.75"	3.75"
Shelf length:	64"	72"
Shelf Depth:	8"	8"
Overall Height:	52"	52"

3 piece scribe set included.

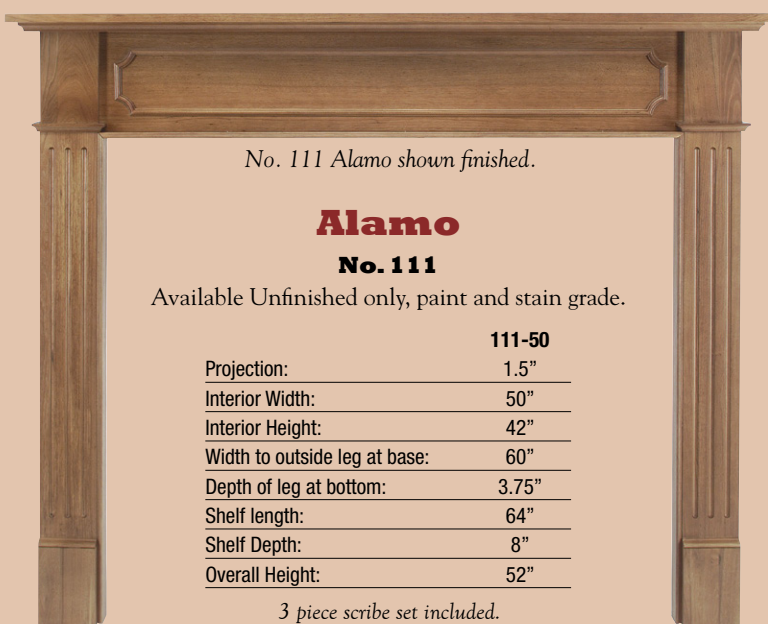

No. 111 Alamo shown finished.

## Alamo No. 111

Available Unfinished only, paint and stain grade.

	111-50
Projection:	1.5"
Interior Width:	50"
Interior Height:	42"
Width to outside leg at base:	60"
Depth of leg at bottom:	3.75"
Shelf length:	64"
Shelf Depth:	8"
Overall Height:	52"

3 piece scribe set included.



No. 140 Classique shown painted.

## Classique No. 140

Available Unfinished only, paint and stain grade.

	140-50	140-56
Projection:	1.5"	1.5"
Interior Width:	50"	56"
Interior Height:	42"	42"
Width to outside leg at base:	71.25"	77.25"
Depth of leg at bottom:	4.375"	4.375"
Shelf length:	73.5"	79.5"
Shelf Depth:	8"	8"
Overall Height:	56"	56"

3 piece scribe set included.

**WARNING! HEAT CLEARANCES MUST BE ADHERED TO FOR INSTALLATION OF THIS PRODUCT; ADHERE TO YOUR LOCAL BUILDING HEAT CLEARANCE CODES AND HEAT CLEARANCES AS STATED BY THE MANUFACTURER OF YOUR SPECIFIC FIREBOX OR STOVE MODEL. FAILURE TO DO SO WILL VOID THE PRODUCT WARRANTY. ALWAYS CONSULT A PROFESSIONAL.**

Product lifestyle photos and drawings are for illustration only. For all surrounds and shelves: hardware is not included to attach the hanger board to the mounting surface.

\*All Pearl Mantels are manufactured individually. Measurements listed are standard, but tolerances may vary. We encourage you to measure your mantel prior to installation and for all custom-fit applications.

Visit our website for more photos and information on our products and fine furniture quality finishes—[www.pearlmantels.com](http://www.pearlmantels.com)

Actual finish colors and distressing may vary from photos. © 1995-2023 Pearl Mantels Corporation®

**WARNING! HEAT CLEARANCES MUST BE ADHERED TO FOR INSTALLATION OF THIS PRODUCT; ADHERE TO YOUR LOCAL BUILDING HEAT CLEARANCE CODES AND HEAT CLEARANCES AS STATED BY THE MANUFACTURER OF YOUR SPECIFIC FIREBOX OR STOVE MODEL. FAILURE TO DO SO WILL VOID THE PRODUCT WARRANTY. ALWAYS CONSULT A PROFESSIONAL.**

Product lifestyle photos and drawings are for illustration only. For all surrounds and shelves: hardware is not included to attach the hanger board to the mounting surface.

\*All Pearl Mantels are manufactured individually. Measurements listed are standard, but tolerances may vary. We encourage you to measure your mantel prior to installation and for all custom-fit applications.

Visit our website for more photos and information on our products and fine furniture quality finishes—[www.pearlmantels.com](http://www.pearlmantels.com)

Actual finish colors and distressing may vary from photos. © 1995-2023 Pearl Mantels Corporation®



# PEARL MANTELS®

Makers of fine furniture for your hearth and home



365 Bedford shown in #63 Gristmill Finish. See page 3.



Non-Combustible Salt Surround. See page 5.



**LOOK FOR THE PEARL!**  
Our Certificate of Authenticity!

Visit our web site at [www.pearlmantels.com](http://www.pearlmantels.com) to learn more about our products, watch videos, see lifestyle shots, download our brochure and much more.

- Follow us on Facebook, Pinterest and Instagram @pearlmantels



- 412 Shenandoah Mantel featured on HGTV's *House Hunters Renovation*

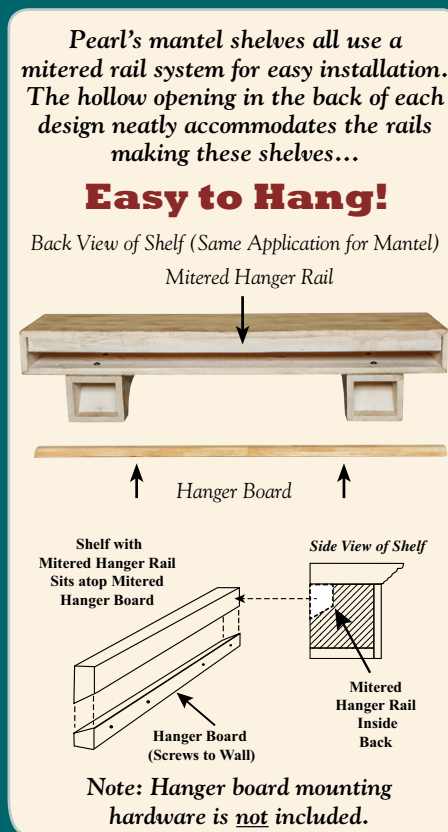

Pearl Mantels® offers great value and quality to stand the test of time. When you decorate your fireplace or walls, pick a Pearl. Limited one year warranty.

Pearl Mantels is a leading manufacturer of fine furniture quality wood and MDF mantels, shelves, adjustable mantels and shelves, and non-combustible mantels and shelves for the fireplace and the home. With over 30 mantel and shelf designs, Pearl continues to innovate and design furniture quality products to meet your needs. Copyright© Pearl Mantels Corporation®. All rights reserved.

Product lifestyle photos and drawings are for illustration only. Mantels are hand painted and hand distressed. Actual finish colors, textures and distressing may vary from photos.

Because each mounting surface is different, hardware is not included to attach the hanger board to the mounting surface. Please consult a professional for advice.

**WARNING! HEAT CLEARANCES MUST BE ADHERED TO FOR INSTALLATION OF THIS PRODUCT; ADHERE TO YOUR LOCAL BUILDING HEAT CLEARANCE CODES AND HEAT CLEARANCES AS STATED BY THE MANUFACTURER OF YOUR SPECIFIC FIREBOX OR STOVE MODEL. FAILURE TO DO SO WILL VOID THE PRODUCT WARRANTY. ALWAYS CONSULT A PROFESSIONAL.**



## Pearl Mantels™ Disclaimer Statement & Limited Product Warranty

**WARNING: FAILURE TO ADHERE TO THE FOLLOWING NOTICES AND WARNINGS MAY CAUSE SERIOUS PERSONAL INJURY, PROPERTY DAMAGE, OR FIRE HAZARDS AND WILL VOID YOUR LIMITED WARRANTY:**

**NOTICE: RECOMMENDED HEAT CLEARANCES-** For safety precautions, regardless of which Wood, MDF, Cast Stone or Non-Combustible Pearl Mantels product you are mounting, follow heat clearances as stated by **local building codes** and the **manufacturer** of your fireplace insert or stove for **COMBUSTIBLE** shelves and surrounds. For a shelf that has a depth under 9", strictly follow heat clearance instructions from the manufacturer for a 9" depth relative to **COMBUSTIBLE** mantels. Each fireplace insert/stove is unique and will have a different heat output and heat clearance; some may require a heat deflector. Follow the manufacturer's installation instructions for your fireplace insert or stove. It is highly recommended that you consult a professional prior to installation of the fireplace insert or stove.

**PEARL MANTELS™ HANGING SYSTEM** – WE RECOMMEND CONSULTING A PROFESSIONAL TO ASSIST YOU WITH THE INSTALLATION OF ANY PEARL MANTELS™ PRODUCTS. PEARL MANTELS™ SUGGESTS THAT TWO PEOPLE BE AVAILABLE FOR INSTALLATION.

**NOTICE: DON'T ACCEPT IT UNTIL YOU INSPECT IT PLEASE INSPECT PRODUCT UPON RECEIPT:**

- Inspect your shipment & product completely both externally and internally for any product damage.
- Is the carton damaged? Is there concealed product damage?
- If you find any damages, reject the shipment and report such damages immediately (within 7 days) to the seller from whom you purchased the product.

### WARNING:

-Pearl Mantels™ does not assume responsibility and disclaims liability for losses, damages, injuries or expenses arising from the installation of the mantel. Each fireplace insert/stove is unique and will have a different heat output; some may require a heat deflector. Follow the manufacturer's installation instructions for your fireplace insert or stove. It is highly recommended that you consult a professional prior to installation of fireplace insert or stove. -Finished mantels are hand painted/finished giving each piece its own unique identity. Due to this process we cannot guarantee any exact match to website pictures, displays, samples, or previously made mantels.

-Unfinished wood mantels will have true characteristics of unfinished wood including, but not limited to, different color tones, grain characteristics and knots, all of which are unique and natural traits of unfinished wood. As every tree is different, so is every unfinished board, and each will accept stain and paint differently. We cannot guarantee any exact match to website pictures, displays, samples, or previously made mantels. We recommend consulting a professional before finishing your products.

-Lifestyle product photos and drawings are for illustrative purposes only and may not be an exact representation or placement of the product.

- Pearl Mantels™ reserves the right to make running minor design changes which may be different than website pictures, displays, samples or previously made mantels.



## LIMITED PRODUCT WARRANTY:

Pearl Mantels™ provides a **limited one-year warranty** from the date of purchase (“Warranty Period”) to the original consumer/purchaser that its products will be free of defects, provided the product is used as intended under normal circumstances.

### This warranty DOES NOT cover the following:

1. damage caused by ordinary wear and tear;
2. damage caused in transit, i.e. freight damage;
3. damage caused by improper installation, accidents (i.e. drops) or improper maintenance, including without limitation failure to adhere to the RECOMMENDED HEAT CLEARANCES notice printed above;
4. damage caused by general misuse or abuse of the product;
5. damage caused by failure to strictly adhere to local building codes for COMBUSTIBLE mantels;
6. damage caused by failure to strictly adhere to the manufacturer of your fireplace insert or stove’s instructions for heat clearances for COMBUSTIBLE mantel shelves and surrounds. For a shelf that has a depth under 9”, strictly follow heat clearance instructions from the manufacturer for a 9” depth relative to COMBUSTIBLE mantels;
7. damage caused by climatic/environmental conditions;
8. mantels that are not an exact match to website pictures, displays, samples, or previously made mantels;
9. mantels accepted with damage and not reported to the seller from which the products were purchased within 7 days of receipt.
10. mantels that have had a minor running design change (i.e. scribe molding design change, enhanced construction change...)

**Making a Warranty Claim:** Detailed photos of the product and the specific warranty issue are **required** to submit your claim. To initiate a claim, you must complete a Pearl Mantels™ Product Claim Form within the Warranty Period and submit it to sales@pearlmantels.com for review.

**Remedies:** With respect to any product deemed defective by Pearl Mantels™ during the Limited Product Warranty period: Pearl Mantels™ will replace the defective product, free of charge.

**This limited warranty covers only the original purchaser of the product and is not transferable to subsequent owners or purchasers and is void** if the product has been installed incorrectly, moved from its initial place of installation or if the product has been altered or modified in any manner inconsistent with the original product shipped by Pearl Mantels™.

**DISCLAIMER: THE REMEDIES DESCRIBED ABOVE ARE YOUR SOLE AND EXCLUSIVE REMEDIES AND PEARL MANTELS™ ENTIRE LIABILITY FOR ANY BREACH OF THIS LIMITED WARRANTY. PEARL MANTELS LIABILITY SHALL UNDER NO CIRCUMSTANCES EXCEED THE ACTUAL AMOUNT PAID BY YOU FOR THE DEFECTIVE PRODUCT. PEARL MANTELS™ DISCLAIMS ANY LIABILITY FOR INCIDENTAL, CONSEQUENTIAL, SPECIAL, OR PUNITIVE DAMAGES ARISING OUT OF BREACH OF THIS LIMITED WARRANTY. ASIDE FROM THIS LIMITED WARRANTY THERE SHALL BE NO OTHER WARRANTIES, EXPRESSED OR IMPLIED. SOME STATES DO NOT ALLOW THE EXCLUSION OR LIMITATION OF INCIDENTAL OR CONSEQUENTIAL DAMAGES, SO THE ABOVE LIMITATION MAY NOT APPLY TO YOU, BUT ONLY TO THE EXTENT IT IS DISALLOWED BY THE LAW OF SUCH STATE.**